



INSTRUCTIONS D'ASSEMBLAGE
ASSEMBLY INSTRUCTIONS

MONARCH
SPECIALTIES INC.

I 3786

TABLE DE SALON -
40" L / TAUPE FONCE / METAL NOIR

COFFEE TABLE -
40" L / DARK TAUPE / BLACK METAL





**POUR DE L'ASSISTANCE OU POUR COMMANDER
DES PIÈCES CONTACTEZ NOTRE DÉPARTEMENT
DE SERVICE À LA CLIENTÈLE.**

**FOR ASSISTANCE OR TO ORDER PARTS
CONTACT OUR CUSTOMER SERVICE DEPARTMENT**

WWW.MONARCHSERVICE.COM

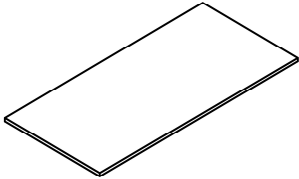
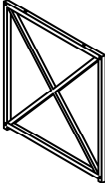
LISTE DES PIÈCES
PARTS LIST

PIÈCE / PART #	IMAGE	DESCRIPTION	QTY / QTÉ
1		<p>TABLE TOP SURFACE DE TABLE</p>	1
2		<p>METAL LEG PATTE EN METAL</p>	2
3		<p>CONNECTOR CONNECTEUR</p>	2
4		<p>CONNECTOR CONNECTEUR</p>	2

LISTE DES PIÈCES DE MONTAGE
HARDWARE LIST

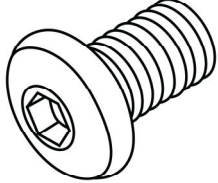
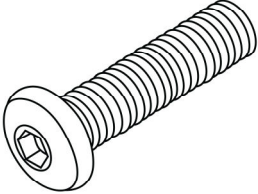
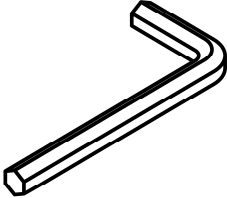
PIÈCE / PART #	IMAGE	DESCRIPTION	QTY / QTÉ
A		<p>ASSEMBLING BOLT - Ø1/4" X 1 1/8"</p> <p>BOULON D'ASSEMBLAGE - Ø1/4" X 1 1/8"</p>	6
B		<p>ASSEMBLING BOLT - Ø1/4" X 1 3/8"</p> <p>BOULON D'ASSEMBLAGE - Ø1/4" X 1 3/8"</p>	8
C		<p>HEX KEY</p> <p>CLÉ HEXAGONALE</p>	1

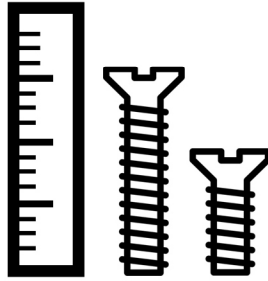

OUTIL DE VÉRIFICATION DE DIMENSIONS DES PIÈCES
HARDWARE DIMENSIONS VERIFICATION TOOL

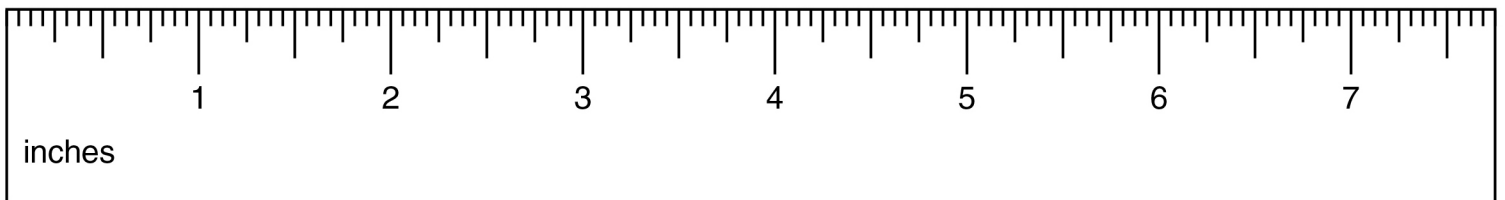

ÉTAPE / STEP 1

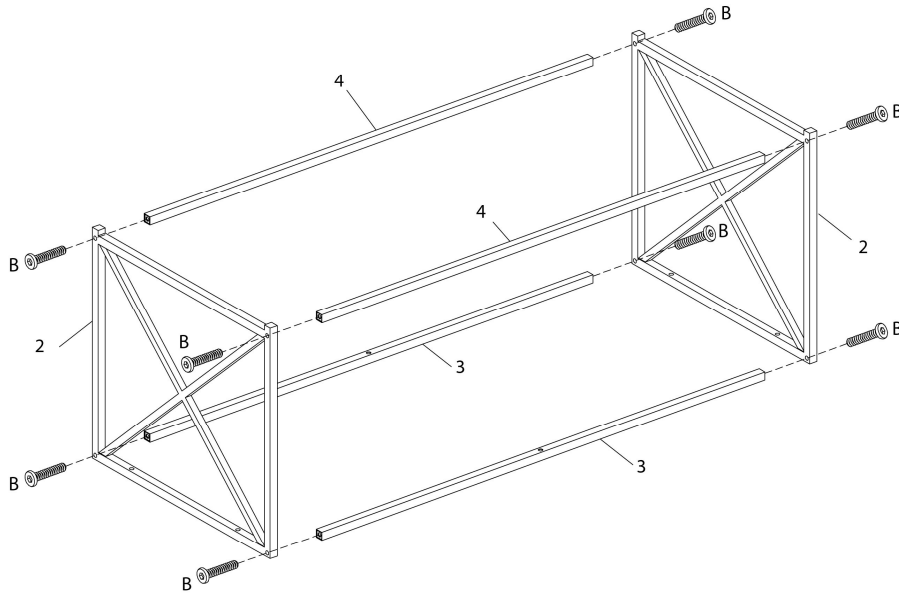

ÉTAPE / STEP 2

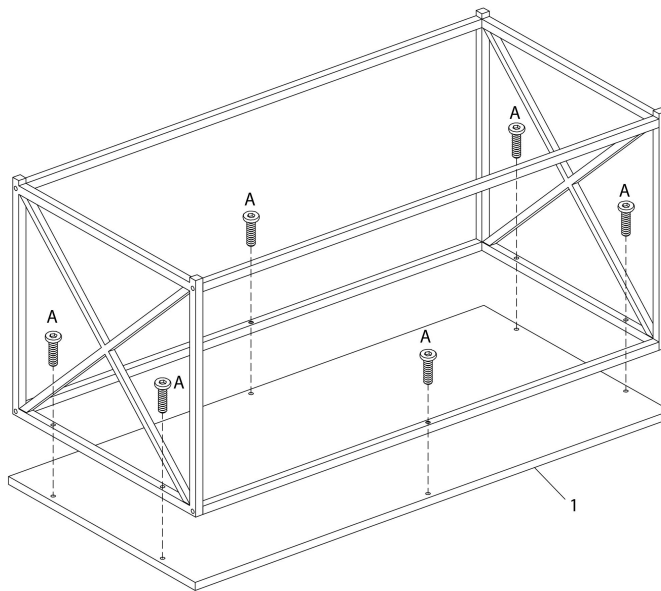

ÉTAPE / STEP 3

